

Plug PowerTOP® - Part no. 3811

- screw terminals
- highly heat resistant contact carrier
- nickel plated contacts
- cable gland and external cable grip

Protection type	IP 67
Ampere	16A
Poles	4p
Voltage	230V
Hertz	50-60 Hz
Earth position	9h
Contact	nickel plated contacts, highly heat resistant contact carrier
Connection technology	Screw terminals

Std. Pack. 10 Qty.

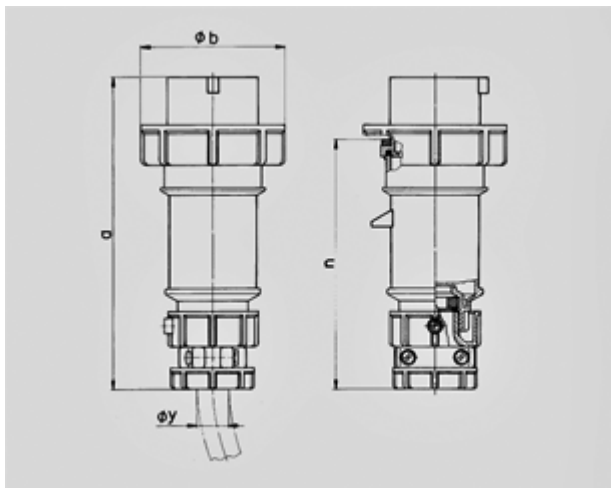

Drawing	Amp.	16			32		
		3	4	5	3	4	5
2 MB 171	Poles						
Dim. in mm	a	162	172	186	199	199	213
	b	71	79	89	95	95	102
	n	129	139	152	157	157	172
	y	19	19	22	24,5	24,5	28,5
Terminal for cond. cross		1	1	1	2,5	2,5	2,5
section (mm ²) min.-max.		-2,5	-2,5	-2,5	-6	-6	-6